



STEAM **EP**

USER MANUAL
VERSION 2.0
OCTOBER 2022



TABLE OF CONTENTS

Table of Contents	2	The Barista Dashboard™	23
Copyright Information	3	Prepare Espresso	29
Welcome	4	Steam Milk	30
Resources	5	Other Machine Calibrations	31
Warranty Information	6	Use Hot Water Tap	32
Symbols	7	Advanced Menu	33
Safety Advisory	8	Adjust Brew Tank Temperatures	38
Water Treatment Requirements	9	Adjust Steam Tank Pressure	38
Recommended Tools & Accessories	10	Adjust Hot Water Dose	39
Installation	11	Other Menu Actions	40
PREPARATION & SETUP		CLEANING & PREVENTATIVE MAINTENANCE	41
Step 1: Prepare Site	12	Clean the Machine Exterior	42
Step 2: Unpack Equipment	13	Clean the Steam Wands	42
Step 3: Connect Plumbing	14	General Group Head Care	42
Step 4: Connect Power	15	Backflush the Group Head	43
Step 5: Fill Tanks	16	Fast Clean	45
Step 6: Turn On Elements	17		
Factory Settings	17		
I'M READY, LET'S BREW THIS!			
Using Slayer Steam EP	18		
Espresso Basics	19		
Installation Checkup	22		



COPYRIGHT INFORMATION

Copyright © 2018, 2016 by Seattle Espresso Machine Corporation

All rights reserved. No part of this publication may be reproduced, distributed, or transmitted in any form or by any means without the prior written permission of the publisher, except in the case of noncommercial uses permitted by copyright law. For permission requests, contact the publisher.

Seattle Espresso Machine Corporation
707 Lind Ave SW
Renton, Washington, USA 98057

SLAYERESPRESSO.COM

TERMS & CONDITIONS

Slayer makes no representations or warranties with respect to the contents of this publication. Information contained herein is subject to change without notice. Every precaution has been taken in the preparation of this manual; nevertheless, Slayer assumes no responsibility for errors or omissions or any damages resulting from the use of this information.

Read this manual completely before installing and operating your Slayer espresso machine. Incorrect installation and operation may result in damage to the equipment, personal injury, or even death. Disregarding the instructions contained herein indemnifies Slayer from all resulting damages and may void the equipment warranty.

For additional safety precautions, see the safety advisory on page 8.



WELCOME

Established in 2007, the Slayer catalog of hand crafted machines continues to grow and meet the demands of Slayer users. One of three machines in the new Steam Box Set, Steam EP celebrates what you have come to love in Slayer, exceptional design, durability and consistent results for high volume cafes. When the details matter, this practical, essential rich model is a barflow dream. Professional features that streamline beverage production creating consistency and fluid movement behind a beautifully crafted espresso machine.

Jason Prefontaine founded Slayer when he had an idea for revolutionizing espresso, but that was just the beginning. The Steam series is the result of his continued commitment to Make Coffee Better™. Expanding the Slayer portfolio of professional equipment, we now turn to the milk-dominated world of high-volume coffee business with the same inventive approach that we first took to espresso.

Slayer Steam EP highlights the ease of use in push button volumetric actuation and a mission to give the owner a total value in form and function. Staying true to our mission Slayer realized it's potential to design the most intuitive, volumetric machine including special product specific features in programmable pre-wetting to prevent excessive channeling. The barista dance is elegant, flows effectively bringing "fun" back to the workflow.

Research and Development is led by Jason Prefontaine and his talented engineers, design by, Chris Flechtner, influenced by the Customer Success team. Steam is the result of a creative collaboration between this dedicated group and many talented friends in the industry. When industry professionals talk, Slayer listens with our most powerful tool being the advice of professional baristas, coffee people and technicians.



RESOURCES

For quick installation, scan the QR code affixed to your machine's crate. For everything else, contact your authorized Slayer reseller or the appropriate party listed below.

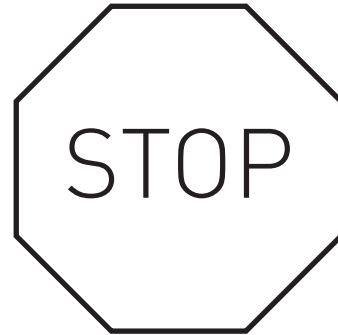

SALES

sales@slayerespresso.com
+1 (206) 284-7171 EXT. 2

MARKETING

marketing@slayerespresso.com
+1 (206) 284-7171 EXT. 6

TRAINING & EDUCATION

training@slayerespresso.com
+1 (206) 284-7171 EXT. 5006

TECHNICAL SUPPORT

support@slayerespresso.com
+1 (206) 284-7171 EXT. 3

ORDERS SUPPORT & SPARE PARTS

orders@slayerespresso.com
+1 (206) 284-7171 EXT. 2

SHIPPING

shipping@slayerespresso.com
+1 (206) 284-7171 EXT. 4



WARRANTY INFORMATION

Slayer provides a 15-month (fifteen month) warranty on all equipment and parts, beginning at the date of shipment from the Seattle headquarters. All equipment and parts are warranted to be free from defect in material or workmanship. Unless otherwise specified in writing, this warranty covers materials only (e.g. equipment, parts) and excludes labor, shipping, and any other costs.

This warranty does not cover accidental damage to equipment, abuse of equipment, or improper use of equipment. "Improper use" includes, but is not limited to, the operation of a machine with inadequately treated water and/or the operation of a machine with inadequate water supply. Any and all damage resulting from inadequate water treatment is expressly excluded from the coverage of this warranty. Read "Water Treatment Requirements" on page #8 for information about water-related issues.

Damage resulting from improper installation of equipment is expressly excluded from this warranty.

Warranty coverage does not include parts that are subject to normal wear and tear, as determined by Slayer. These include, but are not limited to, shower screens, portafilter gaskets, expansion or anti-suction valves, and Preventative Maintenance parts. Warranty coverage excludes glass or plastic parts.

This warranty will immediately expire if you or a third party performs faulty maintenance, excessive use, or neglect of necessary service. This

will include any instances in which, following the occurrence of a defect, you fail to immediately take all suitable measures to limit damage to the equipment and/or fail to provide Slayer with an opportunity to remedy the defect.

Slayer's sole responsibility and liability under the warranty set forth herein is limited to, in Slayer's sole discretion, repair or replacement of defective parts. Unless otherwise specified in writing, this excludes labor, shipping, and any other costs.

To the fullest extent permitted by applicable Washington State (USA) laws, Slayer's warranty set forth herein is limited to the original purchaser of the equipment. Slayer does not, directly or indirectly, offer any warranty to any other person, unless otherwise agreed in writing.

Except as expressly provided herein, all goods are provided to you as they are. Slayer disclaims all representations and warranties, whether expressed or implied, including warranties of title, non-infringement, merchantability, and fitness for a particular purpose.

Warranty claims must be authorized by a Slayer Support representative prior to repair or remedial action.



Symbols



GENERIC WARNING



WARNING: ELECTRICAL HAZARD



WARNING: TRAPPING HAZARD, TAKE CARE WITH HANDS



WARNING: HOT SURFACE



ENVIRONMENTAL PROTECTION



THESE PAGES OF THE MANUAL ARE FOR THE USE OF THE WORKER OPERATING THE MACHINE



THESE PAGES IN THE MANUAL ARE TO BE USED BY QUALIFIED, AUTHORIZED TECHNICAL STAFF



Safety Advisory

This guide includes important instructions about safe espresso machine installation, operation, and maintenance. Read this manual completely before installing and operating your Slayer espresso machine. Incorrect installation and operation may result in damage to the equipment, personal injury, or even death. Disregarding the instructions contained herein indemnifies Slayer from all resulting damages and may void the machine's warranty.

Shipping is coordinated by the customer and performed by a third party. Slayer is not responsible for damage incurred during transport. Upon receiving your machine, carefully inspect all packaging, equipment, and accessories for visible damage. Photograph any visible damage to the crate or espresso machine and immediately contact your shipping company representative within seven days of receipt. Comply with shipping company regulations. Do not connect your machine to power, water, or drainage until all issues have been resolved or your Slayer representative or reseller instructs you to do so. Failure to resolve issues before using equipment may result in further damage or injury.

Installation should be performed by qualified personnel only and must comply with all regulations and requirements of the authorities in your area. If guidance is needed to safely install your machine, contact your Slayer representative or reseller.

It is critical that an appropriately-rated and grounded electrical plug is used to supply your machine with power. This is essential for the safe operation and use of the equipment. Contact your Slayer representative or reseller with questions about this requirement. If you are unsure about the safety of the electrical configuration, do not attempt to install your machine.

Your Slayer espresso machine should only be used for the functions it was designed to perform. Using your machine outside of its defined functionality – as it is described in the “Using Slayer” section on pg. 17 of this guide – may be a safety hazard, resulting in property damage, physical injury, or even death, and will immediately void the warranty.

Slayer espresso machines are electrical appliances that should be used in a safe manner appropriate to devices of their kind:

- **Do not** connect your Slayer espresso machine to electrical power through an extension cord. The machine must be directly connected to an appropriately - rated and grounded power source.
- **Do not** position the power cord in walkways or other high-traffic areas.
- Slayer espresso machines are designed only to be used indoors
- **Before performing service on your machine, disconnect the power source and turn off the water feed.**
- Prior to installation, make sure there is a circuit breaker installed

with a distance between the contacts that allows for complete disconnection when there is a category III overload and that provides protection against current leakage equal to 30 mA. The circuit breaker must be installed on the power-supply in compliance with installation rules. If the power-supply is not working properly, the appliance can cause transitory voltage drops. The electrical safety of this appliance is only ensured when it is correctly connected to an efficient earthing system in compliance with the electrical safety laws in force. This fundamental safety requirement must be verified. If in doubt, request that a qualified electrician inspect the system. The manufacturer cannot be held responsible for any damage caused by the lack of an earthing system on the electrical supply.

PLEASE ALSO OBSERVE THE FOLLOWING RULES FOR INSTALLATION AND OPERATION:

- Room temperature must range between 10° and 32°C (50°F and 90°F)
- Do not install in rooms (kitchens) that are cleaned with jets of water or attempt to clean the machine with jets of water.
- When connected to water mains, only use the supplied parts for installation. If other parts are installed, they must be new (unused pipes and gaskets for the water connection) and they must be permitted for contact with water suitable for human consumption (according to local laws in force).
- The mains water pressure connection should be between a minimum of 300 kPa (3 bar) and a maximum of 500 kPa (5 bar).
- This appliance can be used by children aged from 8 years and above and persons with reduced physical, sensory or mental capabilities or lack of experience and knowledge if they are supervised or given instruction concerning the safe use of the appliance and understand the hazards involved.
- Children must not play with the appliance.
- Cleaning and user maintenance must not be made by children without supervision.
- Use by minors, with or without adult supervision, must not contravene local employment laws.
- Never leave the appliance unattended while it is in use.
- If the appliance is stored in rooms where the temperature can drop below the freezing point, empty the boiler and water circuit tubes.
- Do not expose the appliance to atmospheric agents (rain, sun, and cold).
- **Noise:** assessed acoustic pressure level 70 dB(A) (+/- 1dB).
- If the power-supply cord is damaged, it can only be replaced by qualified and authorized technicians.
- If the machine is used improperly or for purposes other than those described above, it can be a source of danger. The manufacturer will not be held responsible for damages caused by improper use of the appliance.



WATER TREATMENT REQUIREMENTS

Improper water treatment is the most frequent cause of espresso machine damage. Water is complex and varies significantly between regions, so take great care to test the water quality at your location and adjust as necessary. Employ professional help to evaluate your water and administer treatments.

When evaluating water quality, the two most important factors to consider are calcium carbonate and chloride:

Calcium Carbonate: a dissolved mineral that determines the “hardness” or “softness” of water. The desirable range of hardness is 4-5 grains. Over time, calcium carbonate accumulates as a hard substance, called “scale”, and will inhibit the flow of water. Machines subjected to “harder” water (greater than 5 grains) will accumulate scale faster and require maintenance earlier.

Chloride: chlorine combined with an electron from a negatively charged ion. There are many types of chlorides, including calcium chloride, magnesium chloride, sodium chloride, etc. Chlorides produce salts that impart a strong taste, which alters the flavor of the espresso. Chlorides also encourage pitting corrosion, which causes damage to the machine.

Your water filtration company will create a treatment plan based on your water needs. Choose a filtration company that has solutions for addressing issues related to both calcium carbonate and chloride.

Common treatment options include Carbon Filtration, Ion Exchange, and Reverse Osmosis:

Carbon Filtration: a process by which water passes through the granular activated carbon, which attracts and retains many chemicals in the water that have an unpleasant color, taste or odor. Carbon filtration is necessary for all machines. For water with 4-5 grains of hardness, carbon filtration is likely the only necessary water treatment.

Ion Exchange: a process by which water passes through an ion exchange system, where undesirable mineral components are retained and more desirable substances such as sodium are released. An ion exchange system should be used in combination with a carbon filtration system and is especially beneficial for water in the range of 6-9 grains of hardness. This system is relatively inexpensive and effective in removing inorganic substances. It does not, however, remove organic substances, such as bacteria.

Reverse Osmosis with a Blend-Back Valve (or Remineralized RO): a process by which water is forced through a semipermeable membrane with selective pore sizes at high pressure, then blended with the appropriate amount of desired minerals. Reverse osmosis may be a good solution for water in the range of 6-9 grains of hardness and is mandatory for water above 9 grains. When blending minerals with the filtered water, target a TDS (total dissolved solids) value of 75-125 ppm. Experiment with various TDS levels to determine what produces your preferred taste.

All Slayer espresso machines need to be connected to a carbon water filter to remove chlorine, sediments, odor, and undesirable tastes. This requirement is in addition to any other necessary water filtration systems.

Filtration requirements may vary seasonally. Water should be tested during each season to determine the best filtration plan. Once a filtration method has been selected, take note of the filter’s peak capabilities. Replacement of filtration is based on volume and varying levels of hardness. Contact the filtration provider or vendor to inquire about the life expectancy of the filters, then schedule replacement and installation accordingly.

Slayer’s recommended water recipe for ultimate taste and limited scale:

- pH:** 7-9
- Total Hardness:** 2-6 grains
- TDS:** 50-200 mg/L
- Alkalinity:** 40-100 mg/L
- Chloride:** <30 ppm
- Silica:** <10 ppm
- Chloramine:** <.1 ppm
- Chlorine:** <.1 ppm

- **IMPORTANT: Every time a new water filter is installed, thoroughly**
- **rinse the filter before attaching it to your machine or pump. Run water**
- **from the supply line through the filter and down a drain for at least 2**
- **minutes, fully washing the filter and the residue or loose fibers in the**
- **filter cartridge. Skipping this step will cause damage to your machine.**
- **Damage to or failure of your machine due to inadequately treated water**
- **is not covered under warranty.**



RECOMMENDED TOOLS & ACCESSORIES

BEVERAGE PREPARATION

- Espresso grinder
- Scale (must measure in 0.1-gram increments)
- Tamper (must have a 58-58.4 millimeter base diameter)
- Shot glasses
- Steaming pitcher
- Soft towels

EQUIPMENT CARE & MAINTENANCE

- Allen keys (Metric and SAE)
- Crescent wrench
- Flat-head screwdriver
- Group head brush
- Needle-nose pliers
- #2 Phillips-head screwdriver
- Pick or awl
- Pliers
- 9/16 inch socket wrench
- Adjustable wrench
- Slayer Espresso Machine Cleaner
- Steam wand cleaner
- Non-abrasive surface cleaner
- Slayer Lubricant
- Teflon tape



Installation, dismantling, and adjustments must only be performed by qualified and authorized technicians. Carefully read the warnings and rules in this manual because they provide important information regarding safe installation, use and maintenance of the machine. Keep this booklet handy for easy reference.

INSTALLATION

Only qualified service personnel should install Slayer espresso machines. For a list of certified Slayer technicians near you please contact our support department. Incorrect installation may result in injury and/or damage to the equipment. Please read the "Safety Advisory" on page #7 before beginning installation.

Install your Slayer espresso machine with the following ordered steps:

Step 1: Prepare Site	12
Step 2: Unpack Equipment	13
Step 3: Connect Plumbing	14
Step 4: Connect Power	15
Step 5: Fill Tanks	16
Step 6: Turn On Elements	17



STEP 1: PREPARE SITE

Your installation site will require access to power, water, and drainage. Building regulations vary by region, so confirm local requirements before connecting your machine.

Using quality, treated water is essential to achieving the best possible results when preparing coffee and may also extend the life of your machine. Read “Water Treatment Requirements” on page #8 for information about avoiding and addressing water-related issues.

Your Slayer Steam machine needs to be installed on a structure that is capable of supporting its weight, including the weight of the water, once filled:

• SLAYER STEAM WITH ALL TANKS FILLED

- 2-group 100 kilograms (220 pounds)
- 3-group 140 kilograms (305 pounds)

Use the following diagrams to locate and drill holes in the counter for the power cords and plumbing lines. Note that electrical plugs vary in size and a larger hole may be required to accommodate the main power cord.

- **Optional:** prepare two (2) or more identical block risers, each with a maximum height of 15 centimeters (6 inches) and capable of supporting 140 kilograms (305 pounds). The risers should be designed to elevate the machine approximately 15 centimeters (6 inches) above the counter without touching the drain tray or wing legs. Position the risers on the prepared counter, according to the following diagrams.

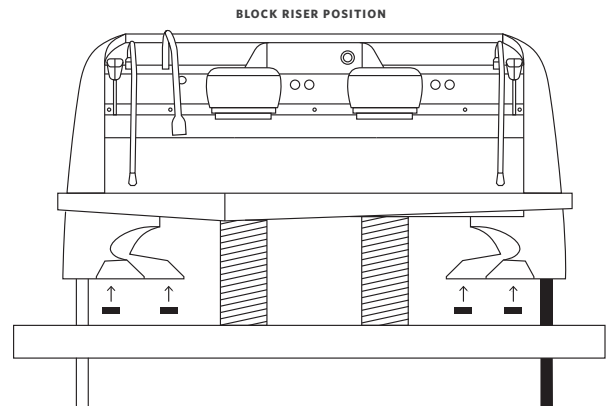
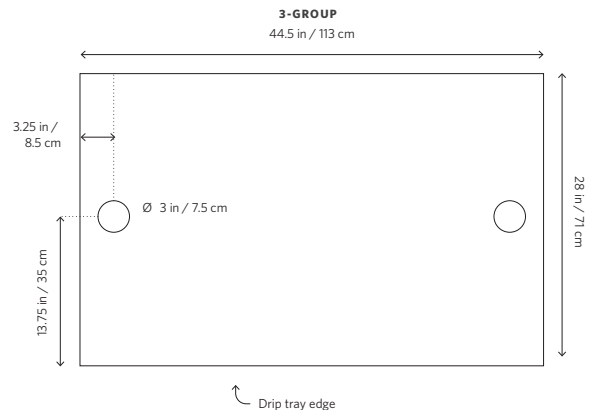
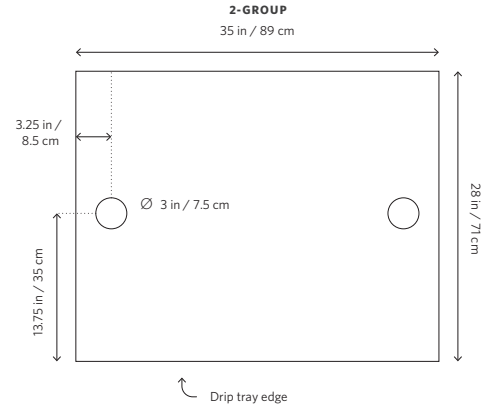



STEP 2: UNPACK EQUIPMENT

Your Slayer Steam EP machine will arrive in a lidded wooden crate, bolted to a pallet at the base. On the outside of the crate, a Steam QR code will link to the appropriate the crate opening procedure. Once the crate is opened, resting atop the machine you will find the accessory box. Unpack with the following steps. At least three (3) able-bodied people will be needed to lift your machine from the pallet.

INCLUDED PARTS

- Four (4) rubber feet

REQUIRED TOOLS & SUPPLIES

- Large flat-head screwdriver or pry bar
- Knife or box cutter
- 9/16-inch socket wrench
- Optional: two (2) or more identical block risers with a maximum height of 15 centimeters (6 inches), capable of supporting 305 pounds (140 kilograms)

PROCEDURE

1. Use a flat head screwdriver or pry bar to remove eight (8) clips located along the lower edge of the crate.
2. Carefully lift the lid from the pallet.
3. Remove the plastic sheet from the machine and identify all crate contents:
 - Slayer Steam espresso machine
 - Attached power cords (2), plumbing lines (2), and drain hoses (2)
 - External rotary pump
 - Accessories box
4. Set aside the accessories box.
5. Locate the two (2) bolts and two (2) nuts that secure the pump to the pallet, then use a wrench to loosen and remove the nuts; set aside the pump.
6. Use a knife or box cutter to remove the banding from the machine body. To protect the machine during installation, keep all other packing material in place.

7. Locate the four (4) bolts that are threaded into the two (2) wing legs, then use a 14mm (9/16-inch) socket wrench to loosen and remove all bolts.
8. Locate the four (4) rubber feet inside of the accessories box and install them on the wing legs. These feet prevent machine slippage and countertop scratches. Later, adjust the feet individually to level the machine.
 - **PRO TIP:** Place the rubber feet on the Steam prior to lifting to your counter top for final placement.
9. Employ the assistance of at least three people to lift the machine up and away from the crate base, minding the attached cords, lines, and hose.
 - Lift only from the chassis (identified in the image below); do not handle the drain tray, cup rail, or any part of the wing legs. To protect yourself during this step, wear thick gloves or drape a small towel over each wrist and forearm.
10. Suspend the machine with the wing channels located directly above the prepared counter holes. If using risers, lower the machine onto the risers. The risers should support the chassis without touching the drain tray.
11. Remove the packing material from the attached cords, lines, and hoses, then run them through the wing channels and counter holes.
12. Lower the machine into the prepared position and remove all packing material.
13. Lift to remove the four (4) cup tray panels; set aside.

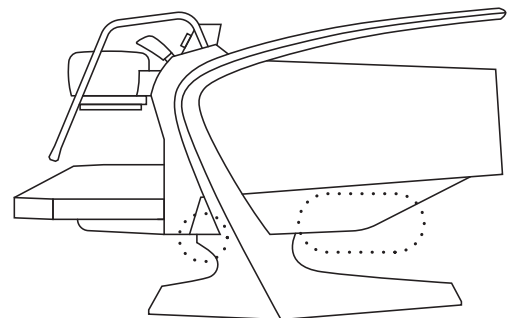



STEP 3: CONNECT PLUMBING

Your Slayer Steam EP machine will arrive with two (2) plumbing lines and two (2) drain hoses attached. One (1) additional plumbing line will arrive inside of the accessories box. A water treatment system is required, but not included. Read “Water Treatment Requirements” on page #8 for information about avoiding and addressing water-related issues.

INCLUDED PARTS

- Two (2) drain hoses with an inside diameter of 5/8 inch (16 millimeters)
- One (1) 30 inch 3/8 inch by 3/8 inch BSP braided hose (in North America, includes 3/8-inch adapter for compression fitting)
- Two (2) 60 inch 3/8 inch by 3/8 inch BSP braided hoses, color-coded
- External rotary pump

REQUIRED TOOLS & SUPPLIES

- Water treatment system (see page #8 for recommendations)
- Adjustable wrench

PROCEDURE

1. Install your water treatment system according to the instructions provided by the manufacturer, then turn off the main water supply.
 - Before use, all treatment systems should be flushed with water for at least two (2) minutes.
2. Ensure that the machine is in position, with all cords, lines, and hoses running through the wing channels and counter holes (per previous steps).
3. Run the two (2) drain hoses to an open gravity drain, ensuring that the lines always slope downwards to ensure constant draining of grey water.
4. Locate the 30 inch by 3/8 inch braided hose inside of the accessories box and use it to connect the water treatment system to the external rotary pump, tightening with a wrench.
5. Locate the two (2) color-coded braided hoses, attached to the machine, and the color-coded connections on the pump. Ensure proper connection of low pressure pump outlet (blue) to low pressure machine inlet (blue), and high pressure pump outlet (red) to high pressure machine inlet (red).
6. Connect each hose to its color-matched connection on the pump, tightening with a wrench.
 - Do not turn on the main water supply.

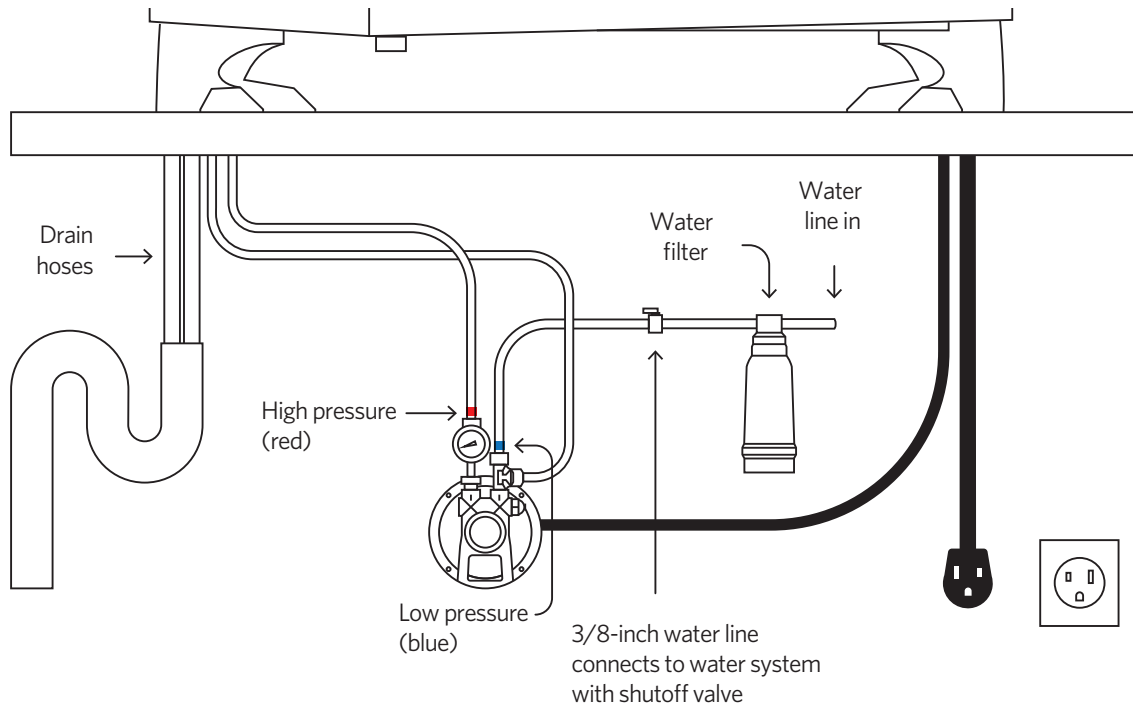



STEP 4: CONNECT POWER

Your Slayer Steam machine will ship with the power configuration requested at the time of purchase. In most cases, this will include a plug end on the power cord. If your machine does not include a plug, do not attempt to wire it yourself. Only an electrician or approved technician should wire the power cord into an appropriately-rated plug end.

INCLUDED PARTS

- External rotary pump and motor

PROCEDURE

1. Ensure that both steam actuators are in the “off” position and the drain hoses and water lines are connected (per previous steps).
2. Insert the main power plug into an appropriately-rated and grounded receptacle
3. Locate the quick connect plug, found on one of the electrical cords that extends from your machine, and insert it into the matching plug unit on the pump motor.

- Do not move the steam actuators to the “on” position. Do not turn on the main water supply.

NOTE: UL machines ship capped with a plug end, CE machines DO NOT.

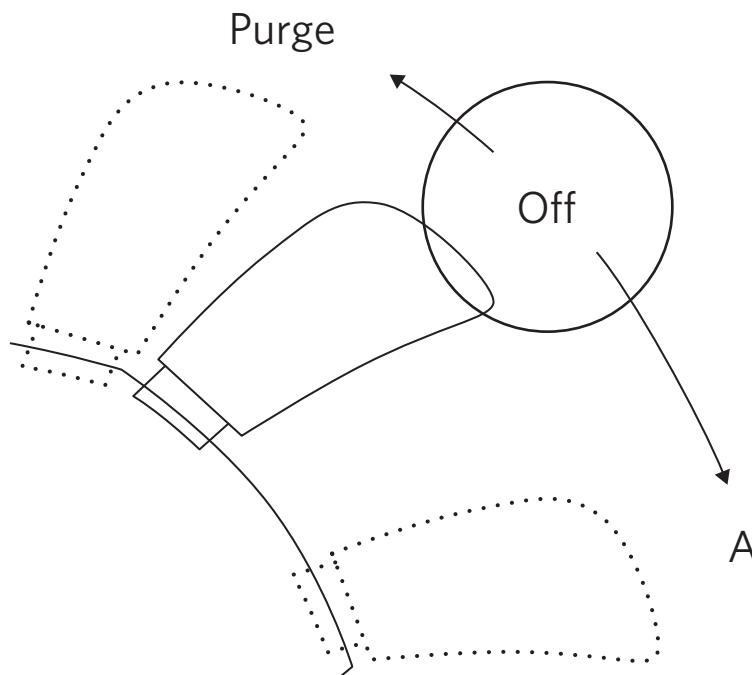



STEP 5: FILL TANKS

PROCEDURE

1. Ensure that both steam actuators are in the “Off” position, the drain hoses and water lines are connected, and the cup tray panels have been removed.
2. Turn on the main water supply.
3. Check the inside of the machine for leaks or collected water.
4. Turn on the power to your machine by pressing the power switch; the steam tank will begin to fill.
 - Filling will take 1-2 minutes and is complete when the pump motor ceases to work and a “click” is heard.
5. Wait until the steam tank has filled completely, then fill the group heads by pressing the brew activation button “on” until water begins to flow.
 - Factory settings for the volumetrics are set (reference Factory Settings on page #20). A double press (within two seconds) on brew button 1 is factory preset for Manual extraction.
6. Press the button again to stop the flow of water through the group.
 - Do not move the steam actuators to the “on” position. Do not engage the white heating element breaker.

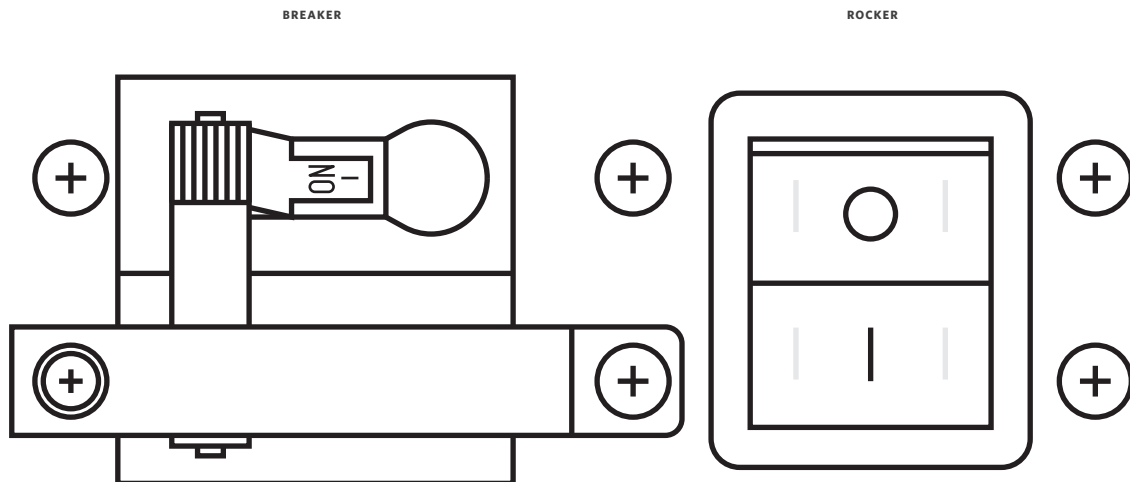



STEP 6: TURN ON ELEMENTS

PROCEDURE

1. Ensure that all brew activation buttons are "OFF" (not lit or blinking), the cup tray panels have been removed, and the tanks have filled completely (per previous steps)
2. Turn on the heating elements by moving the heating element breaker left, to the "on" position.
 - Do not move the steam actuators to the "on" position as the machine will automatically cycle the valves during initial heat up.
3. Wait until the machine has heated fully and the pressure reads 1+ bars on the Barista Dashboard, then move one of the steam actuators down, to the "On" position. If steam is produced, proceed to the next step. If no steam is produced, turn the main power On and Off; wait several minutes before repeating this step.
4. Check the inside of the machine for leaks or collected water.
 - The anti-suction valve on the steam tank may sputter and release small drops of water when first building pressure. During your inspection, check for large pools or steady streams of water.
5. Install the four (4) cup tray panels.

SLAYER STEAM FACTORY SETTINGS

SLAYER STEAM FACTORY SETTINGS

Brew Tank Temperature	93° C (200° F)
Brew Pump Pressure	9 bar with dosed portafilter
Steam Tank Pressure	1.4 bar
Volumetrics Button 1 / 2	30g / 45g
Volumetrics Button 3 / 4	Manual / 2 sec purge
Pre-Wet	Disabled



Using Slayer Steam

Your new machine features sophisticated technologies that are designed to improve numerous aspects of coffee beverage production. These innovations will promote efficiency, accuracy, and comfort on every bar where Slayer Steam EP is found. Whether this is your first espresso machine or the latest in a long career, our instructions should serve as a helpful baseline for getting the most out of Steam EP.

We can't wait to see what you do with it.

CONTENTS

Espresso Basics	19	Adjust Brew Tank Temperature	38
Installation Checkup	22	Adjust Steam Tank Pressure	38
The Barista Dashboard™	23	Adjust Hot Water Dose	39
Prepare Espresso	29	Other Menu Options	40
Steam Milk	30		
Other Machine Calibrations	31		
Use Hot Water Tap	32		
Advanced Menu: Password Protected Option	33		



ESPRESSO BASICS

Coffee “beans” are the seeds from berry-like fruits that grow on shrubs in equatorial regions. After picking and processing, the beans are roasted, ground, and dissolved in water to yield a coffee beverage.

Brewing espresso is a unique method of coffee extraction in which water is added to ground coffee under intense pressure. As a result, the beverage, when compared to filter coffee (e.g. pour-over, immersion), contains a higher concentration of dissolved coffee, feels heavier in the mouth, and asserts stronger flavor.

The espresso machine is the preferred equipment for preparing espresso. Therein, coffee is secured, water is heated, pressure is applied, filtration occurs, and the beverage is dispensed. The entire process takes less than one (1) minute.

Many variables affect espresso extraction and therefore require the attention of the barista. Consider the following generalizations and guidelines when preparing espresso.

COFFEE ORIGIN

Coffee plants are cultivated around the world in equatorial regions that have varying climates and growing conditions. Every location – country, locale, farm, and lot – produces coffee with distinct characteristics that contribute to discernible differences in beverage flavor. Slayer Steam is well-suited for preparing coffee from any single origin, as well as blends of coffees from varying origins.

PLANT VARIETY

Like other fruits (e.g. apples, oranges), coffee beans may come from one of many varieties of the same plant. Common varieties include Typica, Bourbon, Heirloom, and Caturra, among others. Every variety produces coffee with distinct characteristics that contribute to discernible differences in beverage flavor.

PROCESSING METHOD

There are many unique processes by which coffee seeds may be separated from the fruit containing them. Every process produces coffee with distinct characteristics that contribute to discernible differences in beverage flavor. Note these examples:

- **“Washed” process:** increased acidity, enhanced flavor clarity, clean body
- **“Natural” process:** fruit-forward flavor, full body

- **“Pulped natural”, “semi-washed”, and “honey” processes:** borrowed characteristics from washed and natural processes

GREEN COFFEE FRESHNESS

After it has been picked and processed, green (i.e. un-roasted) coffee has a considerable shelf life. However, the potential quality of coffee beverages deteriorates with the age of the green coffee. For best results, buy roasted coffee from a trustworthy supplier that guarantees the freshness of its green coffee.

ROAST PROFILE

Roasting makes the dense, green coffee bean porous and soluble and is the first step in preparing coffee for extraction. Coffee may be roasted to varying degrees by a variety of technologies, each producing coffee with distinct characteristics that contribute to discernible differences in beverage flavor.

Generally, the flavor of espresso prepared from light-roasted coffee will more closely resemble the characteristics of its origin, variety, and processing method (e.g. “bright”, “fruity”, etc.). Conversely, the flavor of espresso prepared from dark-roasted coffee will more closely resemble the characteristics of caramel, dark chocolate and nutty flavors. In some instances the dark roasting process will take a coffee too far into the roast yielding over developed flavors. (e.g. “smoky”).

ROASTED COFFEE FRESHNESS

After roasting, coffee beans are increasingly vulnerable to deterioration. Preserve freshness by storing in a sealed container in a cool, dark area. Ideally, use a container that allows the outward flow of gas, which coffee releases as it ages, but prevents the inward flow of oxygen. Espresso is generally most flavorful when prepared with coffee that has “rested” for at least two (2) days after roasting but has not exceeded three (3) weeks. These guidelines are especially important for dark- roasted coffee, which deteriorates faster than light-roasted coffee.

GROUND PARTICLE SIZE

Preparing espresso requires finely-ground coffee and a professional grinder. When setting up your grinder, target a setting that achieves the recommended beverage yield with the recommended dose weight in the recommended brew time. Continue reading for recommendations



regarding these brewing parameters. Adjust grind as necessary, noting these rules:

Finer grind setting (smaller particles):

- Longer extraction time
- Enhanced body
- Reduced clarity
 - ⋮ Recommended when espresso tastes sour, feels thin, extracts quickly, or has no crema.

Coarser grind setting (larger particles):

- Shorter extraction time
- Reduced body
- Enhanced clarity
 - ⋮ Recommended when espresso tastes bitter, feels muddy, or extracts slowly.

DOSE WEIGHT

Dose weight refers to the amount of ground coffee used for a serving of espresso. When considered alongside the beverage yield, dose weight is part of the brew ratio, which correlates with the perceived strength of the espresso and influences the extraction process. Slayer recommends using a scale to measure 18-21 grams of ground coffee per espresso serving. Begin with 18 grams, then adjust dose weight as necessary, noting these rules:

Larger coffee dose (more weight):

- Increased flavor intensity
- Longer extraction time
 - ⋮ Recommended when espresso tastes sour, feels thin, extracts quickly, or has no crema.

Smaller coffee dose (less weight):

- Decreased flavor intensity
- Shorter extraction time
 - ⋮ Recommended when espresso tastes bitter, feels muddy, or extracts slowly.

For larger doses, please contact Slayer regarding details on larger baskets for you how like to brew.

BED DEPTH

Distribution and tamping ground coffee is essential to forming a puck through which water will evenly flow. Use logic when dosing and distributing to create an even pre- tamp bed. Instead of tamping to a specific pressure (e.g., 30 pounds), Slayer recommends tamping to a specific depth in order to achieve the adequate headspace between the coffee puck and the shower screen. To ensure consistent results, target a tamp depth that levels the top of the tamper piston with the top of the portafilter basket (approximately 1 centimeter).

WATER TEMPERATURE

At the factory, the brew tank temperature is set to 93° C (200° F). Coffee is best brewed with water heated to 92-95° C (195-205° F).

If you do not know which temperature to set your machine at begin with the factory setting, then adjust the temperature as necessary, noting these rules:

Higher temperature:

- Increased extraction rate
- Enhanced acidity
 - ⋮ Recommended when espresso tastes sour.

Lower temperature:

- Decreased extraction rate
- Reduced acidity
 - ⋮ Recommended when espresso tastes bitter.

To adjust the brew temperature, see instructions under Using Slayer > Adjust Brew Temperature on page #38.

WATER PRESSURE

At the factory, the brew pump pressure is set to 9 bar. Generally, espresso is best brewed with water pressurized to 6-10 bar. More dense coffees (such as those grown at a higher elevation, processed with the “washed” method, and/or roasted light) may endure higher pressure, while less dense coffees (such as those grown at a lower elevation, processed with the “natural” method, and/or roasted medium- to-dark) prefer lower pressure.

To adjust the brew pump pressure, see instructions under “Using Slayer > Adjust Brew Pump Pressure” on page #37.



BEVERAGE YIELD

Beverage yield refers to the weight or volume of a serving of espresso. When considered alongside the dose weight, beverage yield is part of the recipe often referred to as the brew ratio, which correlates with the perceived strength of the espresso (sweetness, acidity, body) and influences the extraction process. No one knows your coffee better than your roaster and in some cases you are still the best maestro for conducting great cup experiences. As a baseline Slayer recommends using a scale or graduated shot glasses to measure 25-40 grams or 1.0-1.5 fluid ounces of espresso per serving. Begin with 35 grams or 1.25 fluid ounces, then adjust beverage yield as necessary, noting these rules:

Larger yield (more weight or volume):

- Decreased flavor intensity
- Longer extraction time
 - ⋮ Recommended when espresso lacks clarity.

Smaller yield (less weight or volume):

- Increased flavor intensity
- Longer extraction time
 - ⋮ Recommended when espresso lacks body.

BREW TIME

Brew time refers to the total duration of extraction. Begin with 25 seconds, then adjust brew time as necessary, noting these rules:

Longer brew time:

- Higher extraction yield
 - ⋮ Recommended when espresso tastes sour.

Shorter brew time:

- Lower extraction yield
 - ⋮ Recommended when espresso tastes bitter.



Installation Check-up

 **Warning: after installation, check to see if the machine is working properly**

WATER CONNECTIONS

- No leaks from the connections or tubes

FUNCTIONING

- Boiler and operating pressures are normal.
- The pressure gauge is working properly.
- The expansion valves are working properly

 **Warning: once the machine has been installed and is ready for use, before allowing the worker to start using the machine, wash the internal components according to the instructions below:**

GROUPS

- Install the portafilters in the groups (without coffee).
- Let each group dispense water for about a minute.

HOT WATER

- Continuously dispense hot water until at least 3 liters of water have been dispensed
- See the “Hot water dispensing” chapter in the User’s Manual.

STEAM

- Dispense steam from the nozzles for about a minute.



THE BARISTA DASHBOARD™

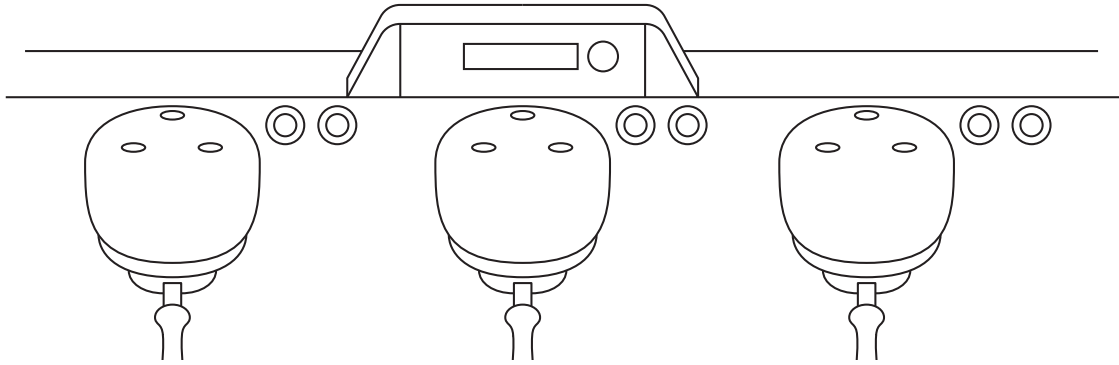

Slayer Steam EP is equipped with a digital interface that displays the essential functions of the machine up front and center for your ease. Through the Barista Dashboard™, you have access to quick and effective brewing parameters and the ability to access two layers of password protected menus as a Manager or Technician. **Password protection is disabled from the factory for ease of install and out of the box calibration and programming.

BASICS OF NAVIGATION

- The menu, settings, and query display is centered within the Barista Dashboard™
- An easy to use menu button is located to the right of the centralized, heads up barista dashboard and, is used to enter the menus, cycle options, make selections, and adjust settings. These actions are accomplished in two different ways
 - Scrolling clockwise gives access to the Barista Menu showcasing Shot Times, Brew Boiler temperatures, Shot Counts (per group), a prompt to Enter the Menu (if passwords are not yet set), Full Cleaning, Quick Cleaning & Switch Off
 - Pressing the Menu button takes the user to the Enter Menu Screen
 - If passwords are disabled, all menu features from Manager to Advanced are visible.
 - If passwords have been enabled, scroll to select between Manager and Advanced by typing in the appropriate password.
- A short hold (2 seconds) will exit you from a setting within any of the three menus, while a long hold (5 seconds) will bring you back to the Home menu. A timeout will occur after 30 seconds, sending the user back to the home menu.

- During the initial setup, select and change the functions to a desired outcome or action.
- The farthest left group is the control center or Master, enabling most actions within the brew groups to be saved across multiple groups or corresponding buttons.
- If saving a volumetric or temperature setting on the left (master) group head, select YES to save details across multiple groups and corresponding buttons or select NO and save details at each individual group button.
- Scroll to the next menu adjustment until setup is complete.
- The menu layout is circular; after cycling through the end of the menu options, the first menu option will reappear.

PASSWORD RESETS

Password protection is disabled upon arrival to ensure fluid installation and setup. When passwords are not enabled scrolling clockwise reveals the Manager and Advanced Menus. The owner/operator has the ability to bypass password protection on the Manager menu while setting it in the Advanced menu. If you do not set a password for the Advanced, Steam EP will function as one long menu featuring the Barista Menu, Manager and Advanced menu options for review and programming. Once setup is complete, password protection can be enabled. Details on how to set the Manager and Advanced Passwords outlined below.

A password can be between 1-8 characters, A-Z letters (uppercase only) and 0-9. Using the blank space or Null < > will indicate the password is completed.

Set Passwords, Manager & Advanced Menus

1. Scroll to PASSWORDS
2. Enter the ADVANCED menu and depress the button



3. Press the button again to accept a null password
4. Scroll to select Manager, use any combination of numbers and letters followed by a space < > indicating the end of the password
5. Scroll to select Advanced, use any combination of numbers and letters followed by a space < > indicating the end of the password
6. Long press and hold the menu button to save and exit back to the Home screen

To disable the passwords the user is permitting access to change multiple details within the machines setup with the exception of a few outliers.

Disable Passwords: Manager & Advanced Menu's

1. Scroll to Advanced menu
2. Scroll counter clockwise to Password
3. Enter the menu and select Manager or Advanced
4. Scroll to the first slot for character to the numerical value 0, one more click counterclockwise to a blank space or <null> value between the brackets Ex; < >
5. Press to select and the password for that menu is now set to null

• **NOTE:** Setting the Advanced password to <null> (off) disables programming a password for the Manager menu.

• **PROTIP:** Hold the button for 2 seconds to go back to the last screen, and 5 seconds to return to the home menu.

The Home Display Menu is rich with real time details on multiple functions within the machine.

- **Heating element activity**, represented by a colon (":"). When a brew tank is being heated, the colon will flash near the brew temperature reading on the corresponding screen.
- **Steam tank fill status**, represented by an upward-facing arrow. When the steam tank is being filled, the arrow will appear next to the steam tank pressure reading.
- **Brew temperature** ("Temp") reading, displayed in tenth-degree (0.1-degree) increments in Fahrenheit or Celsius.
- **Brew time** ("Time") for the previous extraction, displayed in tenth-second (0.1-second) increments. At the beginning of each extraction, the timer will automatically reset and begin counting up from zero (0). At the end of each extraction, the timer will automatically stop and will remain visible until the next extraction begins. Button activations under 2 seconds will not reset the shot time, and under 5 second will not count as a shot in the shot counter. This is to allow the barista an opportunity to flush or purge the group cap after an extraction and still see the value of your previous extraction.
- **Steam tank pressure** ("Stm") reading, displayed in 0.1-bar increments.

MENU OPTIONS

The first level of navigation is the Default Display menu which houses several quick informational updates for your referencing.

1. Group Extraction Times
2. Temperatures
3. Shot Counter Stats Per Group Head
4. Passwords
5. Group Cleaning-Full Clean
6. Group Cleaning-Quick Clean
7. Switch Off

Default Display: Group Extraction Times

SCREEN EXAMPLE:

Gp 1 :	Gp 2 :	Gp 3 :	Stm :
25.2	24.0	25.4	1.5 ↑

- **PROTIP:** Scrolling counter clockwise intentionally showcases the Group Cleaning - Quick and Full to encourage cleaning whenever possible.

The last espresso brew shot time is noted below it's perspective group. Steam tank pressure is displayed on the far right of the screen. The timer does not reset unless it runs for longer than two seconds. This allows the barista to purge the group of residue and not lose sight of the previous shot time.

Brew Group Temperatures

SCREEN EXAMPLE:

Gp 1 :	Gp 2 :	Gp 3 :	TEMP
201.0	201.0	201.0	

Scrolling clockwise (or counterclockwise) through the menu will enable multiple screens. The current brew group temperatures are shown here. (One fewer group will be displayed for a two-group model).

Shots Dispensed Per Group

A shot count is recorded every time a button remains in use longer than five seconds. To view the number of times a shot has been extracted, use the following steps.



SCREEN EXAMPLE:

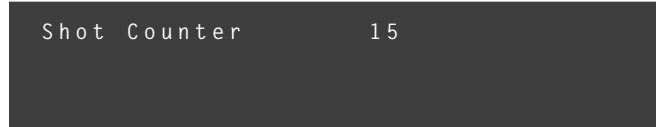

1. Scroll to Shot Counter and depress the button to enter the menu.
2. All the buttons will light up and the screen will prompt you to choose a button.
3. Select the button of interest by single pressing for buttons 1 & 2 and double pressing for buttons 3 & 4. You do not need to exit the screen to verify shot counts button to button.

Enter Password

Factory set passwords are disabled to streamline setup. Scroll to the blank, Null = < > to enter both the Manager and Advanced Menus.

SCREEN EXAMPLE:

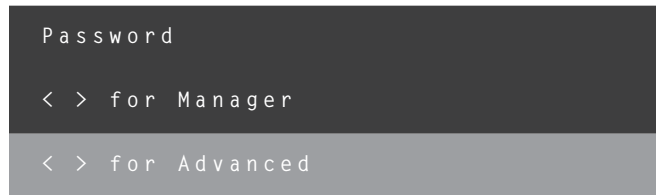

Scroll clockwise for additional options.

Automated Backflush/Cleaning

Backflush cleaning can be done with or without cleaner to ensure quality of taste throughout the day and especially at the end of each day. Follow the steps below to clean the group head of coffee oils and residue.

SCREEN EXAMPLE:



1. Remove the dispersion screw and screen from the group head AND the basket from the portafilter.
2. Place all three parts in a solution bath of Slayer Espresso Machine Cleaner and hot water. Follow the recipe on the container for best results.
3. This cycle is done with the blind basket in place of the standard brew

basket and the proper amount of cleaner dissolved slightly in hot water to activate without issue

4. Place the portafilter in the group head
5. Scroll to **Full Clean**
6. Select to clean ALL groups and depress or Gp 1, Gp 2 and so forth to backflush groups individually.
7. When Full Cleaning cycle is selected in the menu a 100 second rinse and soak is activated. The pattern is ON (water flows into the group) for seven seconds and OFF (water stops flowing) for 3 seconds allowing for a hold time. The sequence repeats 10 times.
8. Once the cycle is complete the screen will prompt, "**Remove Portafilter. Click for Flush**"
9. Remove and depress the menu button to run the 30 second countdown and flushing cycle.

Once complete the screen will default to the Home menu.

- Slayer Espresso Machine Cleaner is a food safe product, however, when residue is left behind it will impart a soapy flavor and odd aromatics unless completely rinsed away.

Quick Cleaning

SCREEN EXAMPLE:



Quick Cleaning option is designed to give you access to a non-detergent cleaning cycle, performed after a busy rush or at a shift change. This cycle is done with the blind basket in place of the standard brew basket with **NO cleaner added**. The Quick Cleaning process is a 12 second cycle, ON for 3 seconds, OFF for 1 second. It repeats itself three times.

1. Leave the dispersion screen and screw in place.
2. Replace the brew basket with a blind basket in the portafilter.
3. Scroll to Quick Clean.
4. Select to clean ALL groups and depress for Gp 1, Gp 2 and so forth to backflush groups individually.
5. Once the clean is complete it will auto reset back to the Home menu.
6. Replace the blind basket with a clean brew basket.



ON/OFF From the Barista Dashboard™

Turning off the machine can be done through the heads up Barista Dashboard™.

SCREEN EXAMPLE:



1. Scroll to Switch Off.
2. Depress the menu button to enter the option.
3. Scroll to select <Yes>.
4. Press the Menu Button to turn the espresso machine back on.

6b: Screen Display Example: OFF

SCREEN EXAMPLE:

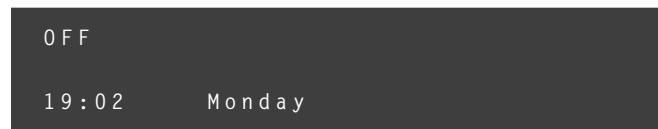

MANAGER MENU, Password Protected Option

The second level menu Manager Menu can be password protected. To access the menu with the stock password, scroll to Enter Password, depress the button which prompts you to enter the password. If this is your first time using the machine and passwords have not been set, the factory password is "null" and can be accessed by simply clicking the button again.

Manager Menu Options:

1. Service Notification
2. Brew Volumetrics Programming & Adjustments
3. Brew Group Temperature
4. Pre-Wet
5. Hot Water Tap Program Dose
6. Steam Boiler Pressure
7. Reset Counters
8. Passwords

Manager Menu Access

SCREEN EXAMPLE:

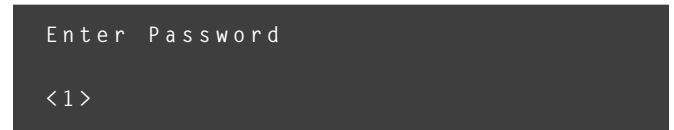

1. Scroll to Manager Menu
2. Select <Null>
 - **NOTE:** To reset the password for both Manager and Advanced Menu's see the instructions on page #35. Scroll clockwise through the menu to see options.

Service Notification

After the password is entered and accepted, the first thing displayed is the Service Notification time left. The value on this screen represents the time left before the next scheduled Preventative Maintenance (PM) service is due. This notification will decrease by one month every 30 days. If the services needed for the machine have not been performed within one year of ownership and the service counter has not been reset, the number will start counting in negative months. Service is now overdue. To view the countdown to service notification:

1. Scroll to Password.
2. Enter the password for Manager Menu. If passwords have not been reset enter <Null>, and press the menu button.
3. Press and hold menu to exit, or wait 30 seconds for the screen to timeout and return to Home.

SCREEN EXAMPLE:



To reset the machines service notification after a Preventative Maintenance repair has been completed, reference page #36 in this manual.



Program Volumetrics Programming

The Slayer Steam EP has the options for four programmable volumetric settings, two per button and four per group. When activating your volumetrics, buttons 1 and 2 pressed once and will showcase the first layer of stored volumetrics. By double pressing the button twice (within two seconds) access to volumetric settings 3 and 4 are now visible. When programming your machine working left to right, the left group is always the control or “master” group head. Volumetrics, Temperature and Pre-Wet can be copied across the corresponding button at each group head via the Copy to All Groups YES/NO feature.

The volumetrics are measured by a number that is related to the flowmeter revolutions, but is custom made to allow easy shot adjustments after the setting have been stored. Setting parameters can be set as low as 20 and up to 1000. M for Manual is also an option.

Programming your volumetrics is intuitive and easy. Grab a scale, your favorite coffee and an open mind to creating the best tastes your espresso has to offer! The buttons are programmable to a numerical value between 20 and 1000 with each click representing approximately 0.5 grams of espresso output. A step by step guide to setting your Volumetrics, Temperatures and Pre-Wet are outlined in the steps below.

1. Scroll to the title screen, **Brew Volume Program Dose** and depress the menu button.

SCREEN EXAMPLE:



2. Select this button by depressing. The screen will again prompt a button selection.

SCREEN EXAMPLE:



3. All Brew buttons will blink, prompting the user to select a button for programming.
4. Select the brew button to adjust and depress. A lit button is now ready for a value.
5. “Brew Volume <###>” displayed on the screen is the current value for volume.
6. Dose coffee into the portafilter and press the same button again to start the brewing process depress to stop the flow at the desired result.
 - Typically, when setting volumetrics with a scale, there is marginal

human error of 2-3 grams when fumbling with multiple moving parts. Before saving the value shared by the flowmeter, turn the menu button up or down to adjust to your desired result (each number will add/subtract about .5 grams of espresso).

7. A new volumetric has been set. Depress the menu button to save your volumetric value.
8. When working from the LEFT farthest group an option to Copy All Groups will prompt you to select YES or NO If you select yes it will copy that buttons value to the same button on the other groups.
9. At this point all brew button lights will blink again prompting the user to select the next button and program a value.
10. Follow this process for all remaining buttons.
11. When volumetric programing is complete exit the menu by pressing and holding the menu button for 2 seconds to continue setup in the Manager menu, or 5 seconds to return to the Home screen.

• **NOTE:** If there is a 1-3 gram difference in the final output of your group heads volumetrics and proper technique has been used for dialing in a shot (ie; using a scale and an exacting coffee recipe), verify the machine flowmeters are calibrated. For a step by step guide toward calibrating your flowmeters for optimum consistency, turn to page #34.

• **PROTIP:** Quickly program any brew button to manual (M) by selecting a button to program, then quickly turn it off. The value will show M as the programmed value.

Volumetric Adjustments

After manually programming a volumetric dose, you may want to slightly increase or decrease the dose based on the taste. This is now easily achievable by slightly adjusting the Volumetric in the Brew Volume Choose Button screen.

SCREEN EXAMPLE:



1. While in the Manager menu, turn the button clockwise to increase the volume and counter clockwise to decrease. each number is roughly .5 grams of espresso.
2. Depress the button to save your setting.
3. If you are working from the LEFT group, an option to Copy All Groups will prompt you to select YES or NO.
4. Choose and press the menu button to save the value across all groups on the corresponding button.
5. Select NO to individually set each volumetric value.



SCREEN EXAMPLE: LEFT GROUP

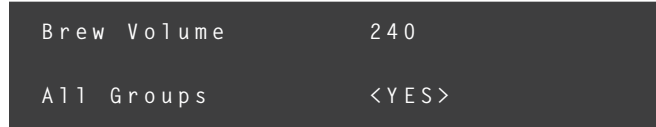

Once the value is saved all button lights will blink, prompting you to select the next button to program volumetric values.

- NOTE: Programming the brew volume does not affect your preinfusion settings however it will affect your extraction. Adjust the grind accordingly.

Brew Group Temperature

Brew tank temperatures are measured in real-time at each group head and displayed in degrees Fahrenheit or Celsius, depending on saved preference. Adjustable in tenth-degree (0.1-degree) increments

- Minimum setting: 82° C (180° F)
- Maximum setting: 97° C (206° F)

SCREEN EXAMPLE:



SCREEN EXAMPLE:

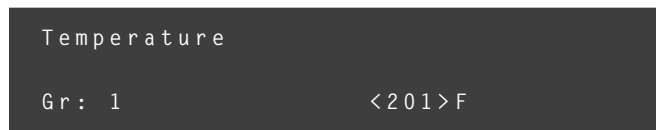

- Working from the left group will enable the ability to copy the temperature to all groups.
- Copy all Groups < YES >** prompt will only occur when programming values with the Master (Left) group. By selecting NO, proceed by individually programming brew group temperatures as desired.
- Exit the menu when programming is completed across all groups

Programmable Pre-Wet

Pre-Wet is a feature designed to maximize extraction through the reduction of channeling. It is disabled upon arrival with both the Pre-Wet and Hold timed values set to zero. Pre-Wet can be set independently on all 4 buttons on each group. The bracket on the left "Pre Wet" showcases the time the valve is open or "wetting" allowing water to enter the brew chamber, up to four seconds. The bracket on the right showcases the time the valve is closed or the "Hold" time, up to four seconds.

- PROTIP: For an effective wetting and hold cycle you must choose a pre-wet and hold value otherwise the extraction will proceed as a normal shot, void of pre-wet.

- Scroll to the Pre-Wet screen and select
- All the buttons will blink ON/ OFF prompting a button selection for programming.

SCREEN EXAMPLE:



- Selecting a button, now program the lit button of choice.
- Two values will appear, program a value between 1 and 4 seconds in Pre-Wet.
- Program a value for water to be paused in the Hold column between 1 and 4 seconds.

SCREEN EXAMPLE:

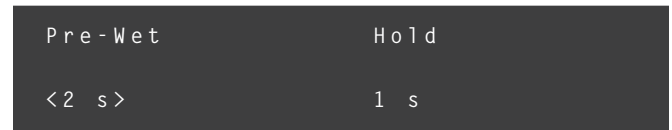

- Save by pressing the menu button and follow the prompts to set the Pre-Wet for all brew buttons.

- NOTE: When the left Control Group window is open for programming the display will prompt "Copy all Groups" display. If YES is chosen the Pre-Wet setting for the button will copy to the same corresponding button across all groups. For example if the Pre-Wet setting for group 1, button 1, single press is chosen and YES is selected to Copy all Groups, this value will copy over across all groups, at button 1, single press. Double press to program buttons 3 and 4 across all corresponding groups.



PREPARE ESPRESSO

Slayer Steam EP utilizes a classic “9-bar” extraction method to produce espresso in a system with custom gicleurs and precision screens. Each brew button allows for two presets in a value range of 20—1000 or M for manual.

The following steps represent a good starting point when first using Slayer Steam EP to prepare espresso.

INCLUDED PARTS

- Portafilter

RECOMMENDED SUPPLIES & EQUIPMENT

- Soft, clean towel
- Espresso grinder
- Espresso tamper
- Large portafilter scale
- ⋮ See complete list on page 10.

PROCEDURE

The following steps represent a good starting point when first using Slayer Steam to prepare espresso.

1. Remove the portafilter from the group head and wipe the basket with a dry towel.
2. Set the grinder to a degree of coarseness suitable for brewing espresso, a fine powder without clumps.
3. Grind and dose 18—21 grams of coffee into the portafilter.
4. Tamp until the top of the tamper base is level with the rim of the portafilter basket, leaving approximately 1 centimeter of empty space above the puck.
5. Set aside the portafilter while you flush the group head, then wipe the group head until dry and lock the portafilter into the group head.
6. Position a shot glass directly under the portafilter.
 - ⋮ The hole pattern on the drain tray indicates a location that is centered under the portafilter.
7. Press one of the brew buttons to begin extraction.
8. Allow the espresso to brew until the preferred extraction has been achieved (when the desired beverage yield has dispensed, or when the desired brew time has elapsed), then depress the button off if using Manual.
 - ⋮ If using volumetric settings, verify results with a scale and calibrate grind size, water volume and temperature accordingly.
9. Remove the portafilter from the group head and discard the puck, then wipe the portafilter with a towel to remove grounds and oil.
10. Flush the group head to purge grounds and oil, then return the portafilter to the group head.



STEAM MILK

Slayer Steam EP utilizes a dedicated Steam Boiler with adjustable Steam pressure. The steam actuators allow for three (3) positions: “off”, “on”, and “purge”.

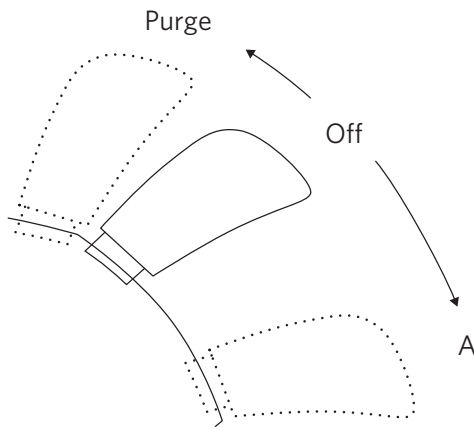

The following steps represent a good starting point when first using Slayer Steam to prepare milk.

RECOMMENDED SUPPLIES & EQUIPMENT

- Steaming pitcher
- Soft, clean towel
- ⋮ See complete list on page #10.

PROCEDURE

1. Fill a pitcher with the desired volume of fresh, cold milk.
2. Aim the steam wand toward the drain tray or into a towel and briefly move the steam actuator up to the “purge” position to release steam and condensation.
3. Submerge the steam tip in milk and move the actuator down to lock it into the On position.
4. Move the pitcher down to expose the steam tip to the surface of the milk, incorporating fine air bubbles.
5. Submerge the steam tip when the milk reaches body temperature
6. Tilt the pitcher to form a whirlpool and evenly disperse microfoam throughout the pitcher.
7. Turn off the steam wand when the pitcher feels hot to the touch. The final milk temperature should be 55—65° C (130—150° F).
8. Wipe the steam wand with a damp cloth, removing all milk residue, then purge again to remove any milk residue inside the wand.



Scalding hazard! Use the appropriate insulating devices to move the water and steam nozzles.



OTHER MACHINE CALIBRATIONS

ADJUST BREW PUMP PRESSURE

INCLUDED PARTS

- External rotary pump

REQUIRED TOOLS

- Slot screw driver
- Small crescent wrench

PROCEDURE

1. Locate the pressure gauge and adjustment screw on the external rotary pump.
2. Loosen lock nut on pump screw.
3. Move the brew actuator to the on position.
4. Turn screw clockwise to increase the pump pressure. Turn counterclockwise to decrease the pump pressure.
5. Tighten lock nut to hold setting.
6. Return the brew actuator to the off position and tighten the lock nut.

ADJUST HOT WATER TEMPERATURE

Slayer Steam features a blending valve that draws water from the steam tank and main cold water line simultaneously. Custom water temperatures are configured with the blending valve. Adjust the hot water temperature with the following steps.

REQUIRED TOOLS

- Phillips Head Screwdriver
- Flat Head Screwdriver

PROCEDURE

1. Remove the side panel on the left side of the machine by removing two phillips screws or remove the cup tray. Locate the blending valve near the steam solenoid valve. [see photo below]
2. Adjust the hot water temperature:
 - **Clockwise** rotations increase the hot water temperature.
 - **Counterclockwise** rotations decrease the hot water temperature.
3. Verify the temperature at the hot water tap with a digital thermometer.

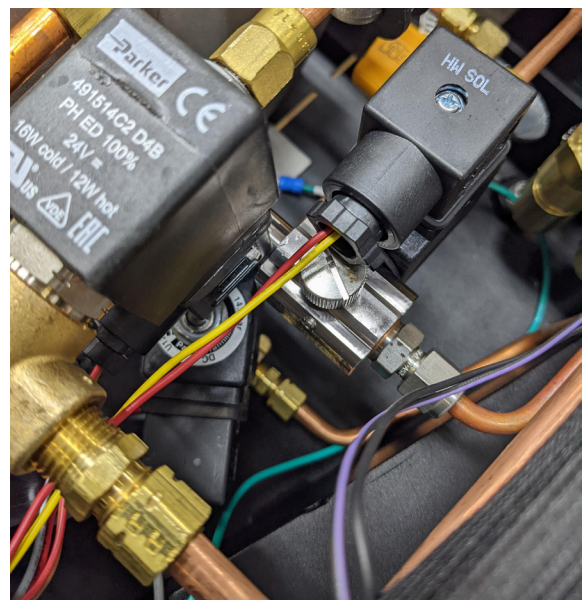



USE HOT WATER TAP

Slayer Steam features a blended hot water valve that draws from the steam tank and main cold water line. The hot water tap is located on the left side of the machine, adjacent to the steam wand. Water volumes can be configured in the Barista Dashboard™.

Dispense hot water by pressing the button to the right of the tap. The flow of water will stop automatically, after the pre-configured volume has been dispensed. To adjust the hot water tap volume use the instructions detailed below. The range of setting is available from 0.0 to 20 seconds, adjustable in 1/10 seconds increments. To program the metered water volume exiting the hot water tap, use the detailed instructions below.

1. Scroll to the Password screen and enter the code for Manager menu access
2. Scroll to the screen labeled Hot Water Program Dose and select.
3. A programmable screen will appear.
4. Turn the button clockwise to increase time and counter clockwise to decrease the time the water is running.

SCREEN EXAMPLE:



5. Long press and hold the program button to save and exit the menu.

STEAM BOILER PRESSURE

Steam pressure is displayed on the Home menu. Pressure is displayed in 1/10 bar increments and is adjustable between a range of .08 bars to 1.5 bars of atmospheric pressure. The colon will flash when the steam boiler is heating. To adjust the steam boiler pressure review the details below.

1. Scroll to the Password screen and enter the code for Manger menu access
2. Scroll to the screen:
3. Steam Boiler Pressure
4. Adjust the pressure by turning the button clockwise to raise the pressure in tenth bar increments (0.1-bar), and counter clockwise to lower the pressure.

PROGRAM SCREEN:



5. Long press and hold the menu button to save and exit the menu.

Adjusting this value can increase the pressure in which the steam exits the steam wand. Adjust accordingly to achieve the "just right" steam pressure along with exceptional technique needed to achieve perfect microfoam.

RESET COUNTERS: SHOT COUNTERS

Each group is equipped with the ability to record the number of times a button is pushed to extract a shot. The value is NOT recorded as a shot if the time the button is activated is less than five seconds, thus removing the false reading associated with purging the group before and after a shot is extracted for cleanliness. Viewing the counters showcases usage per button, per group and can act as a record of how the machine is used. Viewing this count is done in the Home menu with no password needed. Resetting the value can be adjusted any time from the manager menu. An unchangeable permanent value can be viewed in the Advanced Menu under the title Lifetime Count, details on page 33.

1. Scroll to Passwords, enter your password for the Manager menu.
2. Rotate the jog wheel clockwise to Reset Counters.
3. Scroll and select YES or NO.

SCREEN EXAMPLE:

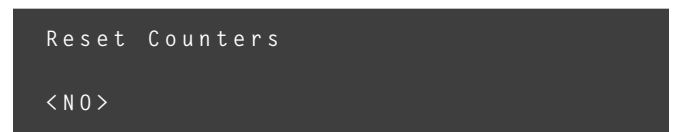

4. Long press and hold the program button to save and exit.



Scalding hazard! Use the appropriate insulating devices to move the water and steam nozzles.



ADVANCED MENU, PASSWORD PROTECTED OPTION

The second level of navigation is the Advanced Menu, and is a continuation of the Manager Menu higher level access to critical settings and Preventative Maintenance services done by a Slayer certified technician. We have intentionally removed the password for this section for ease of setup but recommend you password protect to remove the potential for unintentional reboots and adjustments without the proper calibration tools or knowledge base. The list below showcases the extended menu with Advanced programming options.

While navigating the Home menu, access the Advanced Menu by scrolling to the "Password" title screen and entering < > leave the value blank if visiting for the first time. To program both the Manager and Advanced Menu password, visit the instructions on page #35.

- Do not interact with the Advanced Menu before reading this manual in its entirety. Then - if unsure - consult your Slayer representative, reseller, or qualified service personnel. All ADVANCED menu title screens are intentionally displayed in uppercase as they are high level adjustment menus.

ADVANCED MENU OPTIONS

1. Service Notification
2. Brew Volume Program Dose
3. Brew Group Temperature
4. Pre-Wet
5. Hot water Tap Program Dose
6. Steam Boiler Pressure
7. Reset Counters
8. **Heater Control Element ON/OFF**
9. **Temperature C / F**
10. **Lifetime Count**
11. **Set Time/Date**
12. **Times for Power Save to Begin**
13. **Times for Power Save to End**
14. **Brew Temp Offset**
15. **Auto-Fill Delay**
16. **Flowmeter Calibration**
17. **Reset Passwords**
18. **Reset Service Notification**

- The basic Manager Menu only displays the first seven options.

HEATING ELEMENTS ON/OFF

This menu allows for individual boilers both brew and steam to be turned ON or OFF.

1. Scroll to the Passwords title screen press and type in the password for the Advanced Menu.
2. The option to adjust ALL heating elements ON/ OFF, universally, will be presented.
3. Rotate the jog wheel to cycle between "On" and "Off".
4. Press and release the jog wheel to confirm your new setting and proceed to the next step.
5. Repeat steps 4-5 for all remaining settings:
 - Gp1 (heating element for leftmost brew tank)
 - Gp2 (on 2-group, right brew tank; on 3-group, middle brew tank)
 - Gp3 (rightmost brew tank; 3-group only)
 - Stm (steam tank)
6. Long press and hold the program button to save and exit

TEMPERATURE °C / °F (SELECTION)

All temperatures displayed can be shown in either Celsius or Fahrenheit. Once selected this readout will be visible across brew and steam tanks. To adjust the temperature readout in °C or °F follow the details below.

1. Scroll to the Password title screen, select and enter code for the Advanced Menu.
2. Rotate the menu button clockwise until the "Temperature" setting appears.
3. Press and release the jog wheel to enter the "Temperature" setting. The option to adjust the unit of temperature measurement will be presented.
4. Rotate the jog wheel to cycle between "F" (Fahrenheit) and "C" (Celsius).
5. Long press and hold the program button to save and exit

To adjust the boiler temperatures, see instructions under Using Slayer > Adjust Brew Tank Temperature in the Manager menu on page #38.



LIFETIME COUNT (SHOT COUNTER)

A non-resettable number displays the total count of shots extracted over the lifetime of the machine, per group head (and not individual button counts). Scrolling through this menu will showcase the full shot counts per group for all programmable volumetrics. A shot is not recorded if the button is turned On and Off within 5 seconds of being activated, excluding the group purge or rinse from the total value. To successfully view your shot counts to date use the details listed below. The hot water tap total count is also visible in this menu.

1. Scroll to the Passwords title screen in the Home menu, select and enter the correct PW for the Advanced Menu.
2. Turn the menu button clockwise to Lifetime Count enter the menu by depressing the button.
3. Scroll through the menu to read the number of shots extracted on each group.

SCREEN EXAMPLE:

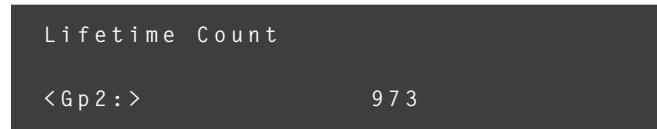

4. Scroll to see the number of times the Hot Water Tap button has been engaged

SCREEN EXAMPLE:

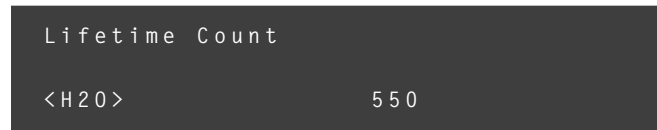

5. Long press (5 sec.) and hold to exit the Home Menu, short press (2 sec.) to continue working in the Advanced menu program platform.

SET TIME/DATE

Setting time and date is critical in order to utilize Power Save mode and to enact your countdown to service clock. Use the following steps to set Time and Date.

1. Scroll to Passwords, enter your password for the Advanced Menu
2. Rotate the jog wheel clockwise until the "Set Time/ Day" setting appears.
3. Press and release the jog wheel to enter the "Set Time/ Day" setting. The option to adjust the clock type will be presented.
4. Rotate the jog wheel to cycle between "12H" (12-hour clock) and "24H" (24-hour clock).

5. Press and release the jog wheel to confirm your new setting and proceed to the next step. The option to adjust the hour will be presented.
6. Rotate the jog wheel to adjust the hour.
7. Press and release the jog wheel to confirm your new setting and proceed to the next step.
8. Repeat steps 6-7 for all remaining settings:
 - Min (minute)
 - Day
9. Long press and hold the program button save and exit the menu

- Time/Day must be programmed before you can move onto setting up
- Power Save options.

TIMES FOR POWER SAVE TO BEGIN/ END

- **REMINDER:** Time and date must be set in advance to proceed with the setup of Powersave mode. Power-save settings can be set to all days or individual daily schedules if hours of operation change from weekday to weekend schedules. When power-save is "OFF", all systems are normal.
- When power-save is "ON", the machine is in sleep mode.

When the machine is in power save mode the resting values are as follows:

- Steam pressure is reduced to 0.3 bars
- Brew temperatures are reduced to 100.0° F (37.7 C)

All systems begin heating for normal operation thirty (30) minutes before power- save is scheduled "OFF".

Set: Power Save Begin

1. From the Home menu, scroll to Passwords and enter the Advanced menu password.
2. Rotate the menu button clockwise until the "Times For Power Save To Begin" title screen appears, press to enter.
3. Set the time.

SCREEN EXAMPLE:

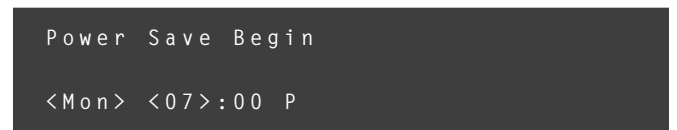

(Example times displayed, set accordingly)

4. Choose to Copy ALL days <YES> or <NO> and set individual times for power save to begin if closing times vary day to day.



- **PROTIP:** For ease of programming, choose Program ALL days the same, then individually adjust Saturday and Sunday start and end times as needed.

Set: Power Save End

1. From the Home Menu, scroll to Passwords and enter the Advanced menu password
2. Rotate the menu button clockwise to “Times For Power Save to End” title screen appears, press to enter
3. Set the time.

SCREEN EXAMPLE:

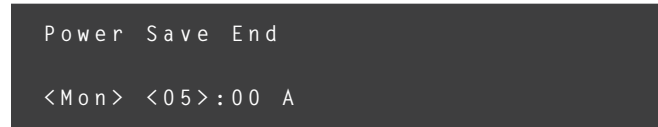

4. Choose to “Copy ALL days” <YES> or <NO> and set individual times for power save to end if cafe hour start times vary.

BREW TEMP OFFSET (PROGRAMMING)

- **IMPORTANT:** To configure the offsets, you must have a scace device or defer to a certified Slayer technician. This can NOT be performed with hand held temperature probes.

Brew temperature calibration settings are used to ensure accurate heating by compensating for physical variations between temperature probes.

Use the offsets to adjust displayed brew temperature, when different from actual. Brew temperature offsets are adjustable in tenth-degree (0.1-degree) F or C increments.

Brew temp offset

When adjusting a brew temp offset you will need a scace device or the professional services provided by a Slayer technician.

1. Press and hold the jog wheel above the left group head for five seconds to activate the Advanced Menu options.
2. Rotate the jog wheel clockwise until the “Brew Temp Offset” setting appears.
3. Press and release the jog wheel to enter the “Brew Temp Offset” setting. The option to adjust the offset for the leftmost group head (Gp1) will be presented.
4. Rotate the jog wheel to adjust the brew temperature offset for the leftmost group head in tenth-degree (0.1-degree) Fahrenheit increments: clockwise rotations increase the offset value; counter-clockwise rotations decrease the offset value.

- If the displayed brew temperature is lower than the actual brew temperature, increase the offset value. If the displayed brew temperature is higher than the actual brew temperature, decrease the offset value.

5. Press and release the jog wheel to confirm your new setting and proceed to the next step.
6. Repeat steps 4-5 for all remaining settings:
 - Gp2 (on 2-group, right brew tank; on 3-group, middle brew tank)
 - Gp3 (rightmost brew tank; 3-group only)
7. Press and release the jog wheel to confirm your new setting and return to the menu for additional adjustments OR move the brew actuator Left to Right to save and exit the Advanced Menu.

AUTO FILL DELAY

To prevent pressure loss during espresso brewing and in order to prioritize consistent brew parameters the machine firmware has the ability to prevent boiler autofill while extracting espresso on any group head. The stock setting for Auto Fill Delay is <DISABLED>.

1. From the Home Menu, scroll to Passwords and enter the Advanced Menu password.
2. Scroll to Auto-Fill Delay
3. Choose < ENABLE >
4. Press and long hold the menu button to confirm your new setting and exit to the Home menu.

- **NOTE:** this feature is not recommended for cafes making 500-1000+ drinks per day.

FLOW METER CALIBRATION

The flow meter calibration is designed to ensure that volumetrics set points are consistent group to group. Calibration of your flow meters requires proper tools; a scale, coffee ground to the appropriate setting and a consistent recipe. Calibration is a manual, fine tuning step done at the point of install and setup. While factory set manufacturer tolerances are minimal between flow meters, Slayer has applied the following calibration exercise to sync up subtle performance differences, to ensure consistent performance group to group. A properly calibrated will machine will deliver volumetrics plus or minus 1 gram of your desired amount while a machine that without proper flow meter calibration will deliver volumetric results plus or minus 2 grams of your desired amount. Once calibrated continue to spot check volumetrics to verify consistent performance on a quarterly basis. Follow the steps below to calibrate your flowmeters.



1. Program button ONE (Left) across all groups to the same volumetric value by adjusting the menu button clockwise to increase and counter clockwise to decrease the value. Exit back to home menu

SCREEN EXAMPLE:



SCREEN EXAMPLE:

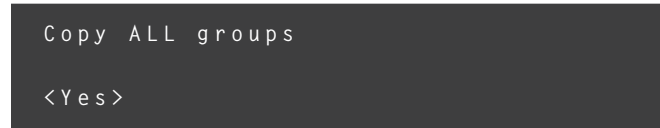

- **NOTE:** Always follow a strict recipe when in calibration menus to ensure accuracy.
2. Dose coffee into the portafilter, verify with a scale that reads to the .01 gram.
 - Example: 18 grams in
 3. Brew from the Master (left) group, using a scale to verify the brewed espresso weight.
 - Example: 35 grams out
 4. Continue with this recipe and process across all groups.
 5. If the OUT weight varies (higher or lower) by more than 1 gram from the Master group, adjust the volumetric value in the Volumetric Calibration menu up or down to calibrate.
 - Proceed to the following step to calibrate. If it's within 1 gram of the Master group rebrew to confirm it stays in that range. If it does there is no need to change the calibration value.
 6. From the Home menu, scroll to Password and enter the Advanced menu access password
 7. Scroll to "FlowMeter Calib.", depress to enter the menu
 8. Select the correct group to edit
 9. Adjust each number up or down based on the values from step 7. Each number will add/remove about 1 gram of espresso output. Ex: 2nd group has 33 grams out (not 35 as the master group), INCREASE the value 2 numbers.
 10. Press and long hold the menu button (5 seconds) to confirm your settings and exit back to the Home menu.
 11. Rebrew across all the groups to verify volumetrics have less than 1 gram difference in the OUT weight.

Spot Check, Calibrate

The volumetrics are controlled through the Flow meters, factory tuned

at a 30g dose for brew button 1 (activated by a single press on the brew button) and a 45g dose for brew button 2. This volumetric configuration is configured by referencing four different measurements:

- Volume of water it takes to fill the headspace (water from the puck surface up to the dispersion screen).
- The average volume of water left behind in a saturated puck.
- The released water through the three way valve at the end of a shot
- The actual espresso you extract

If your yield is set to the same value on each group, but the extractions does not match, you will need to calibrate your Flow Meter. Using a scale and timer for optimum results proceed with calibration of your flowmeters. Perform steps 6 - 10 in the previous section "Flow Meter Calibration" for your spot check.

MASTER PASSWORD RESET

Slayer Steam EP is equipped with three layers of programming and usage through the Barista Dashboard™. The factory passwords are simply set at <null> for the Manager Menu access and <null> for the Advanced Menu access. Passwords can be between 1—8 characters, A—Z letters (uppercase only) and 0—9. Using the blank space < > will indicate the password is completed. To reset these passwords use the steps below:

1. Scroll to the Passwords screen, select and enter the factory setting <null>, press enter
2. Scroll to the Passwords menu and select either the Manager or Advanced menu to change your passwords
3. Scroll clockwise to select a combination of letters A—Z and numbers 0—9, along with a blank space < >
4. Scrolling counter-clockwise will start with a blank/null space < >, followed by 9—0, and the letters Z—A
5. Select a value and click to save. Each time a value is clicked, the next available slot will open for a value.
6. To complete the password scroll to the blank < > space, indicating the end of the password and press OK.
7. Repeat steps 1—5 to program both the Manager and Advanced Menus.
8. Press and long hold the menu button to save and exit.



RESET SERVICE NOTIFICATIONS

Preventative Maintenance is ongoing and key to optimum performance of your espresso machine. Daily, weekly, quarterly and ANNUAL maintenance should be done ahead of issues to prevent costly breakdowns and extensive repairs. The Slayer Steam EP alerts you via a countdown clock of when your next suggested Preventative Maintenance repair should be done. Based on volume you can schedule your countdown clock to start at 12, 6 or 3 months depending on your volume. After 30 days the countdown drops by one month. If the counter goes lower than 1 month it will now read in negatives, a warning that service is in past the recommended scheduled. To reset the countdown toward your next service notification after a Preventative Maintenance service has been performed on your machine use the following steps.

1. Scroll to the Password screen in the Home menu, select and enter the code for the Advanced menu.
2. Scroll to Service Notification and select.
3. Scroll to select <No> or <Yes>.
4. If <Yes> is selected, a prompt will ask you to choose the interval to begin the countdown.
5. Select your interval, press to save.
6. Press and long hold to save and exit.

Disable Service Notifications

1. Scroll to the Password Screen in the Home menu, select by depressing the Menu button and enter the code for the Advanced menu.
2. Scroll to Service Notification, depress the menu button to select.
3. Scroll to Select <Yes>.
4. Select the option <OFF>.
5. Press and hold (2 seconds) to save and exit back to the Advanced menu or long hold (5 seconds) to exit to the Home Menu.



ADJUST BREW TANK TEMPERATURES

At the factory, the brew tank temperatures are set to 93° C (200° F). Adjust the brew tank temperatures with the following steps.

PROCEDURE

1. Press and release the jog wheel above the left group head to activate the menu for all group heads
2. Rotate the jog wheel clockwise until the “Brew Temperature” setting appears.
3. Press and release the jog wheel to enter the “Brew Temperature” setting.
4. Rotate the jog wheel to adjust the brew tank temperature in tenth-degree (0.1 degree) increments: clockwise rotations increase the temperature; counter-clockwise rotations decrease the temperature.
5. Press and release the jog wheel to confirm your new setting and proceed to the next step; the option to apply your new setting to all group heads will be presented.
6. Rotate the jog wheel to cycle between “N” and “Y”. Selecting “N” will apply your new setting to the designated group head only; selecting “Y” will apply your new setting to all group heads.
7. Press and release the jog wheel to confirm your new setting and return to the menu, and scroll to the next menu option.
8. To configure a different temperature for each brew tank, repeat steps 1-7 at each group head.

ADJUST STEAM TANK PRESSURE

At the factory, the steam tank temperature is set to 1.4 bar (25 psi). Adjust the steam tank temperature with the following steps.

PROCEDURE

1. Press and release the jog wheel above any group head to activate the menu.
2. Rotate the jog wheel clockwise until the “Steam Tank” setting appears.
3. Press and release the jog wheel to enter the “Steam Tank” setting.
4. Rotate the jog wheel to adjust the steam tank pressure in tenth-bar (0.1 bar) increments: clockwise rotations increase the temperature; counter-clockwise rotations decrease the temperature.
5. Press and release the jog wheel to confirm your new setting and return to the menu, or press and hold the jog wheel to confirm your new setting and exit the menu.



ADJUST HOT WATER DOSE

Slayer Steam utilizes a timer to dispense pre-configured volumes of hot water. Adjust the hot water dose with the following steps.

PROCEDURE

1. Press and release the jog wheel above the left group head to activate the main menu.
2. Rotate the jog wheel clockwise until the “Hot Water Dose” setting appears.
3. Press and release the jog wheel to enter the “Hot Water Dose” setting. The “on” button, found directly next to the hot water tap, will begin to flash.
4. Rotate the jog wheel to adjust the hot water dose in tenth-second (0.1-second) increments: clockwise rotations increase the hot water dose; counter-clockwise rotations decrease the hot water dose.
5. Press and release the jog wheel to confirm your new setting and return to the menu, or press and hold the jog wheel to confirm your new setting and exit the menu.
 - Alternatively, after completing steps 1-3, you may skip to the “Alternative Procedure”, below.

ALTERNATIVE PROCEDURE

1. Complete “Adjust Hot Water Dose” steps 1-3, above.
2. Press and release the “on” button to dispense hot water. The Barista Dashboard will begin a timer to display and record the duration of the dose.
3. Press and release the “on” button again to stop the flow of hot water. The duration of the dose will be recorded.
4. The hot water dose may not exceed 20 seconds.
5. Press and release the jog wheel to confirm your new setting and return to the menu, or press and hold the jog wheel to confirm your new setting and exit the menu.



OTHER MENU ACTIONS

Through the Advanced Menu, you may access additional settings. Do not interact with the Advanced Menu before reading this manual in its entirety, then – if unsure – consulting your Slayer representative, reseller, or qualified service personnel.

From the idle screen, access the Advanced Menu by pressing and holding the jog wheel, until a beep sounds. At any time, you may press and hold the jog wheel or move the actuator Left to Right to save your new settings and exit the menu.

HEATER CONTROL ELEMENT ON/OFF

1. Press and hold the jog wheel above the left group head for five seconds to activate the Advanced Menu options. Press and release the jog wheel to enter the “Heater Control” setting. The option to adjust all heating elements, universally, will be presented.
2. Rotate the jog wheel to cycle between “On” and “Off”.
3. Press and release the jog wheel to confirm your new setting and proceed to the next step.
4. Repeat steps 4-5 for all remaining settings:
 - Gp1 (heating element for leftmost brew tank)
 - Gp2 (on 2-group, right brew tank; on 3-group, middle brew tank)
 - Gp3 (rightmost brew tank; 3-group only)
 - Stm (steam tank)

TEMPERATURE CHOOSE C OR F

1. Press and hold the jog wheel above the left group head for five seconds to activate the Advanced Menu options.
2. Rotate the jog wheel clockwise until the “Temperature” setting appears.
3. Press and release the jog wheel to enter the “Temperature” setting. The option to adjust the unit of temperature measurement will be presented.
4. Rotate the jog wheel to cycle between “C” (Fahrenheit) and “F” (Celsius).
5. Press and release the jog wheel to confirm your new setting and return to the menu for additional adjustments OR move the brew actuator Left to Right to save and exit the Advanced Menu.

SET LANGUAGE

1. Press and hold the jog wheel above the left group head for five seconds to activate the Advanced Menu options.
2. Rotate the jog wheel clockwise until the “Language” setting appears.
3. Press and release the jog wheel to enter the “Language” setting
4. Scroll to select your desired Language.
5. Press and release the jog wheel to confirm your language and return to the menu for additional adjustments OR move the brew actuator Left to Right to save and exit the Advanced Menu.



Cleaning & Preventative Maintenance

Keeping your machine clean and properly maintained is essential to ensuring espresso quality and equipment longevity. Espresso machines require both daily cleaning and ongoing periodic maintenance. The frequency with which these tasks should be completed will depend on the location and use of your espresso machine. The following instructions assume heavy use in a commercial setting. Inquire with our spare parts department to order preventative maintenance (PM) kits for use every 12-18 months.

Visit slayerespresso.com/support, and explore our knowledge base for details on preventative maintenance.

CONTENTS

Clean the Machine Exterior	42
Clean the Steam Wands	42
General Group Head Care	42
Backflush the Group Heads	43
Fast Clean	45



CLEAN THE MACHINE EXTERIOR

Use a soft, clean towel to wipe the surfaces of the machine. Do not use abrasive cleaners. Small amounts of window cleaner may be used on glass and metal components.

CLEAN THE STEAM WANDS

Immediately after steaming milk, clean the exterior of the steam wand by wiping it thoroughly with a damp towel, then clear the interior by briefly moving the steam actuator up to the “purge” position.

If clogging occurs, soak the steam wand in hot water for several minutes, then purge while submerged. For tough clogs, use toothpick to unplug the holes in the tip and use an approved espresso machine steam wand cleaning solution.

GENERAL GROUP HEAD CARE

Regular cleaning and backflushing optimizes machine performance and espresso flavor by preventing the buildup of coffee oils. Complete the following steps for each grouphead as part of every backflush cycle or as needed, at least once daily.

REQUIRED TOOLS

- Cleaning brush
- Flat-head screwdriver

RECOMMENDED SUPPLIES

- Soft, clean towel

PROCEDURE

1. Remove portafilter from group head, then use a cleaning brush to scrub the portafilter gasket, loosening oil and coffee grounds.
2. Use a flat-head screwdriver to remove the dispersion screw and shower screen, then rinse with clean water.
 - Ensure that the dispersion screw holes remain clear of coffee grounds, as they may otherwise damage internal parts of the group head.
3. Use a damp towel to wipe oil and grounds from the face and sides of the dispersion block, as well as the portafilter body.
4. Return the clean dispersion screw and shower screen to the group head.
 - Failure to reinstall the dispersion screw and shower screen before next use may cause the group head to clog. Do not attempt to brew espresso or backflush the group head before the dispersion screw and shower screen have been correctly installed.
5. Rinse the portafilter with hot water, then insert the portafilter basket and lock it in the group head.



BACKFLUSH THE GROUP HEADS

Through the Barista Dashboard, Slayer Steam automates backflush cycles for each group head. Backflush with an approved espresso machine cleaning powder at least once daily. Complete the “Fast Clean” procedure as needed.

To maximize efficiency and lengthen the life of wearable parts, keep on hand two (2) complete sets of shower screens, dispersion screws, portafilter baskets, and portafilter springs. Alternate between sets for each full backflush cycle.

INCLUDED PARTS

- Blind portafilter insert
- Replacement portafilter

REQUIRED TOOLS

- Cleaning brush
- Flat-head screwdriver

RECOMMENDED PARTS & SUPPLIES

- Replacement shower screens, one (1) per group head
- Replacement dispersion screws, one (1) per group head
- Replacement portafilter baskets, one (1) per group head
- Replacement portafilter springs, one (1) per group head
- Approved espresso machine cleaning powder
- 1 liter (or larger) heat-tolerant container
- Soft, clean towel

PROCEDURE

1. Complete “General Group Cleaning” steps 1-3 on page #42. Set aside shower screens and dispersion screws.
2. Prepare a solution of hot water and approved espresso machine cleaning powder in a 1 liter (or larger) heat-tolerant container.
3. Remove portafilter baskets and portafilter springs from all portafilter bodies.
4. Add all shower screens, dispersion screws, portafilter baskets, portafilter springs, and portafilter bodies to prepared solution. Soak for a minimum of 20 minutes, then rinse thoroughly with clean water. Meanwhile, complete remaining steps.
 - Do not submerge portafilter handles in solution
 - or fading will occur.
5. Use a flat-head screwdriver to install a second set of shower screens and dispersion screws, then complete the following steps for each group head.
6. Install a blind insert in a replacement portafilter, add cleaning powder, and lock it in the group head.
7. Press and release the jog wheel on the Barista Dashboard™ to activate the menu.
8. Rotate the jog wheel clockwise until the “Group Cleaning” setting appears.
9. Press and release the jog wheel to enter the “Group Cleaning” setting. The option to select a cleaning program will be presented.
10. Rotate the jog wheel to cycle between cleaning programs:
 - All (all group heads)
 - Gp1 (leftmost group head)
 - Gp2 (on 2-group, right group head; on 3-group, middle group head)
 - Gp3 (rightmost group head; 3-group only)
11. Press and release the jog wheel to select and initiate a cleaning program. A countdown will begin at the group head(s) running the cleaning program. The cleaning program is complete when a buzz sounds and the shot light pulses.
12. Follow the prompt on the screen to remove the portafilter(s) from the group head(s), then press and release the jog wheel to continue a purging cycle. The purging cycle is complete when the shot light pulses, after approximately thirty (30) seconds.
13. Reassemble the portafilter, inserting the portafilter spring and portafilter basket, then lock it in the group head.
14. Repeat steps 6-13 for each group head, as needed.



Basic Backflushing Steps

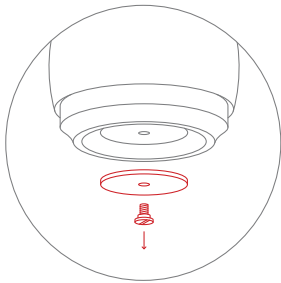

1

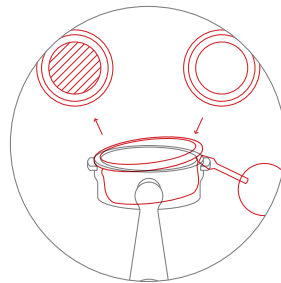

2

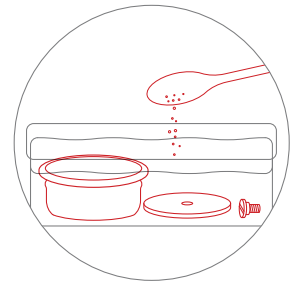

3



4

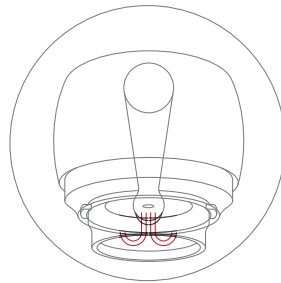

5

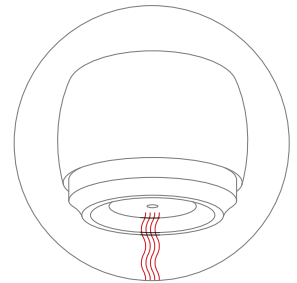

6

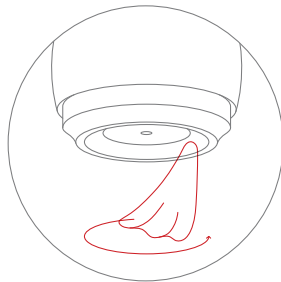

7

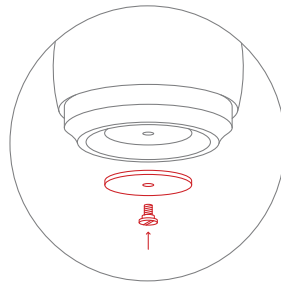

8

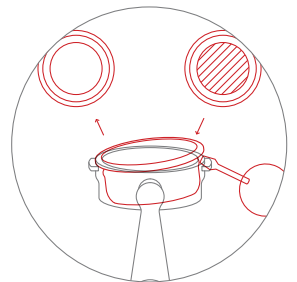

9



FAST CLEAN

Designed to be done without the use of detergent after the busy portion of the day, at the shift change or when changing out the coffees in the hopper. Leave the screen, screw in place. Complete the following steps for each group head whenever your machine requires minor cleaning.

INCLUDED PARTS

- Blind portafilter insert

REQUIRED TOOLS

- Group brush or non-fiber towel
- A blunt end object

RECOMMENDED SUPPLIES

- Soft, clean towel

PROCEDURE

1. Remove portafilter from group head, then use a cleaning brush to scrub the portafilter gasket, loosening oil and coffee grounds.
2. Replace portafilter basket with a blind insert and lock it in the group head.
3. Press and release the jog wheel above the group head to activate the menu.
4. Rotate the jog wheel counterclockwise to the "Fast Clean" setting.
5. Press and release the jog wheel to enter the "Fast Clean" setting. The option to select a cleaning program will be presented.
6. Press and release the jog wheel to select and initiate Fast Clean.
7. Follow the prompt on the screen to remove the portafilter from the group head, then press and release the jog wheel to continue.
8. Remove the blind insert from the portafilter and use a damp towel to wipe oil and grounds from portafilter body.
9. Rinse the portafilter with hot water, then insert the portafilter basket and lock it in the group head.
10. Repeat all steps for each group head, as needed. This feature is available per group and intuitively placed last on the menu for counter clockwise turn to, quick activation.



Make
Coffee
Better